

NOTES:

1. 6" AND 8" THICK BLOCKS ALSO AVAILABLE
2. EACH BLOCK COVERS 1.44 SQ. FT.

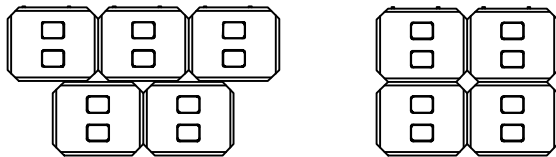

Channel Flex
Flexible Revetment System

EROSION PREVENTION PRODUCTS

P.O. Box 891586
Houston, TX 77289-1586
(713)947-6889

**CHANNEL FLEX
BLOCK DETAILS**

CAD File Name:

FLEX BLOCK

SCALE: N/A

SHEET 1 OF 8

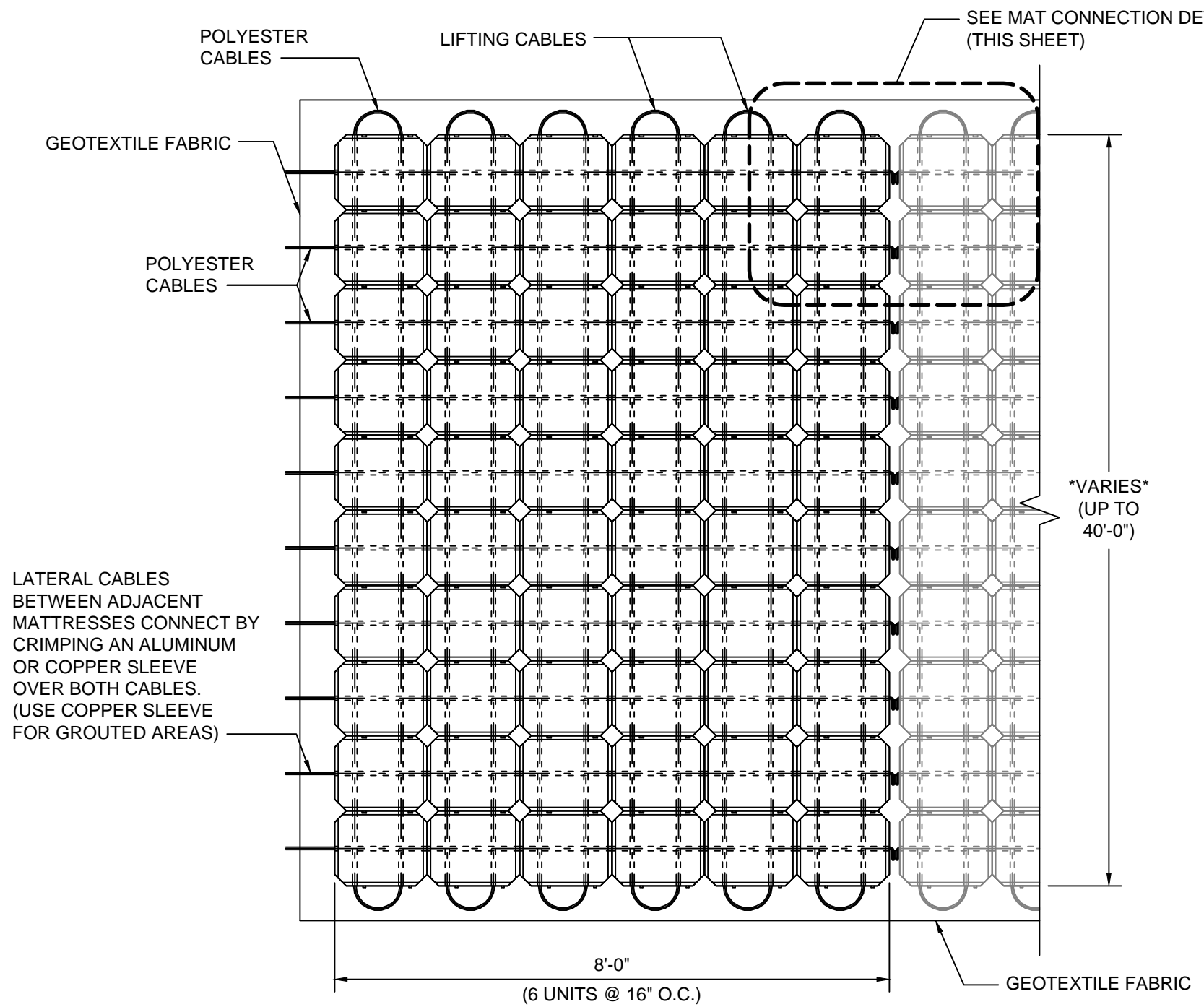

**PARALLEL ACBM
PLAN VIEW**

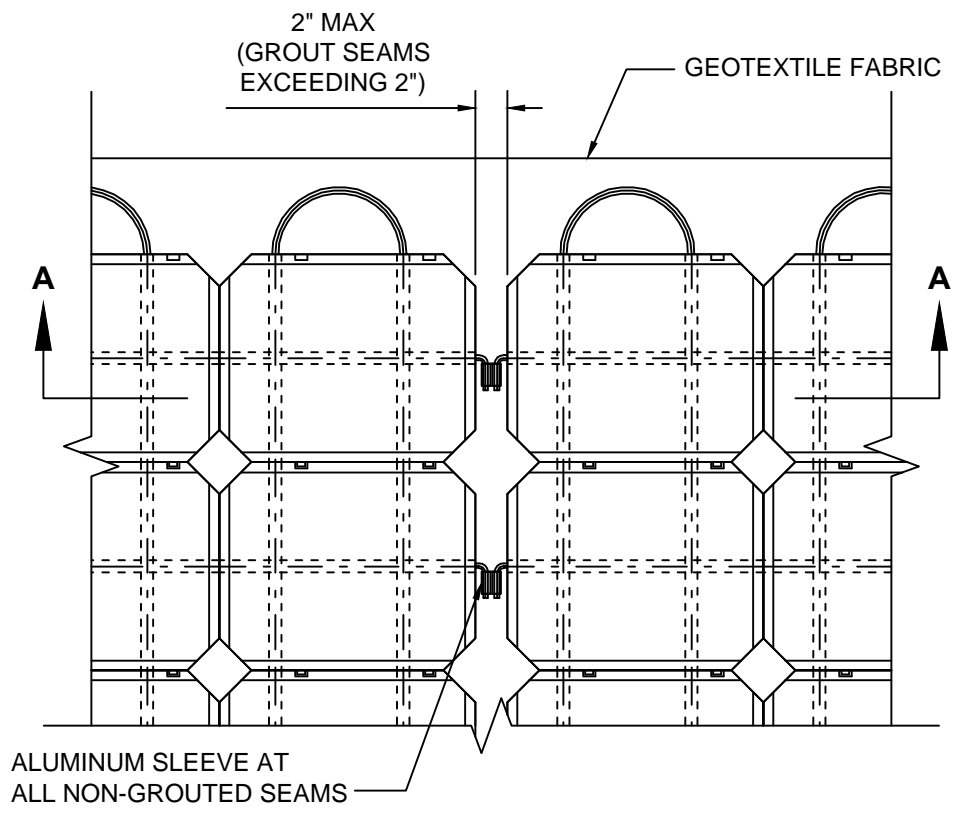

**TYPICAL CONNECTION
OF TWO MATS**

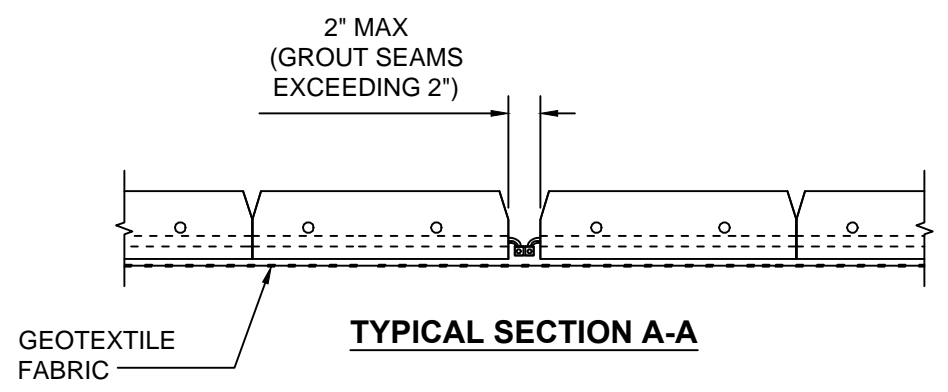

TYPICAL SECTION A-A

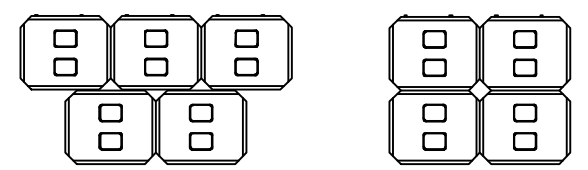

Channel Flex
Flexible Revetment System

EROSION PREVENTION PRODUCTS
P.O. Box 891586
Houston, TX 77289-1586
(713)947-6889

**PARALLEL ARTICULATED
CONCRETE BLOCK
MATTRESSES (ACBM)
ASSEMBLY DETAIL**

CAD File Name: PARALLELMAT

SCALE: N/A SHEET 2 OF 8

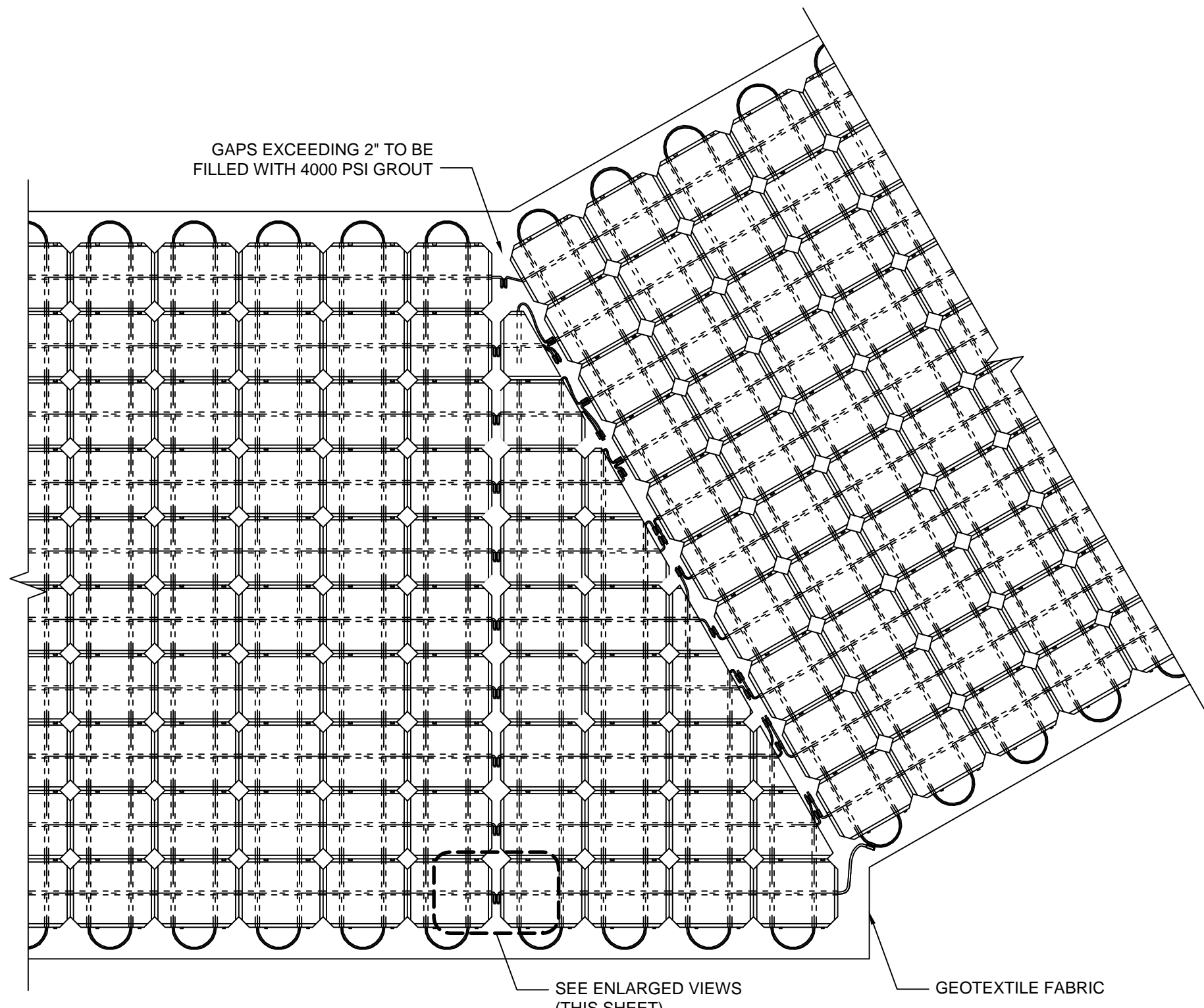

GAPS EXCEEDING 2" TO BE FILLED WITH 4000 PSI GROUT

SEE ENLARGED VIEWS (THIS SHEET)

GEOTEXTILE FABRIC

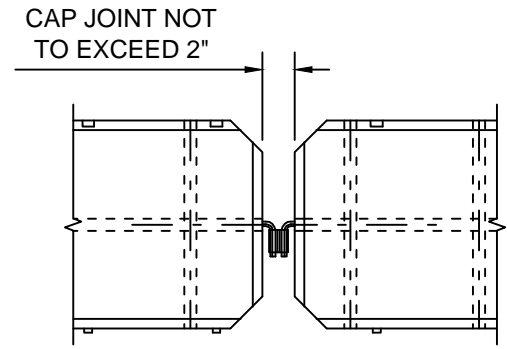

CAP JOINT NOT TO EXCEED 2"

**TYPICAL MAT CONNECTION
ENLARGED PLAN VIEW**

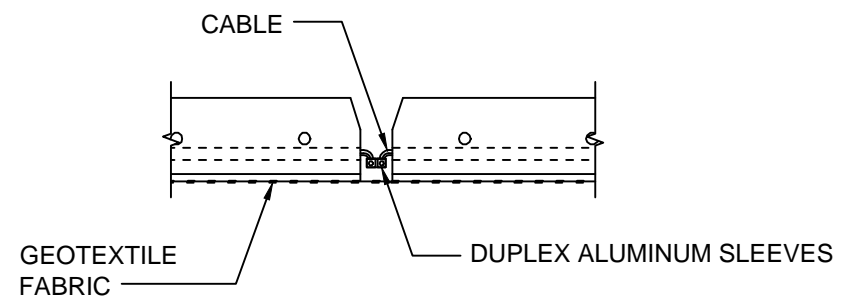

**TYPICAL MAT CONNECTION
ENLARGED SECTION VIEW**

**ANGLED ACBM CONNECTION
PLAN VIEW**

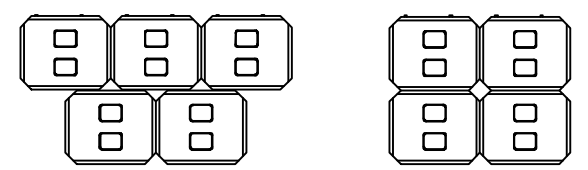

Channel Flex
Flexible Revetment System

EROSION PREVENTION PRODUCTS
P.O. Box 891586
Houston, TX 77289-1586
(713)947-6889

**ANGLED ARTICULATED
CONCRETE BLOCK
MATTRESSES (ACBM)
CONNECTION DETAILS**

CAD File Name: ANGLEDMAT

SCALE: N/A SHEET 3 OF 8

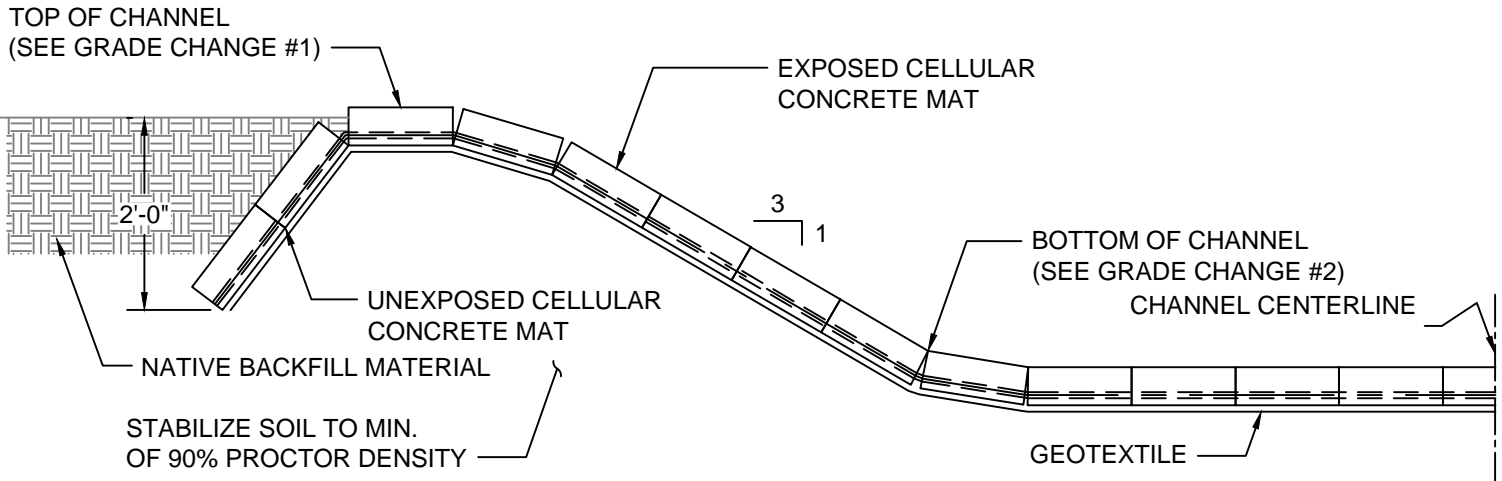

TRAPEZOIDAL CHANNEL

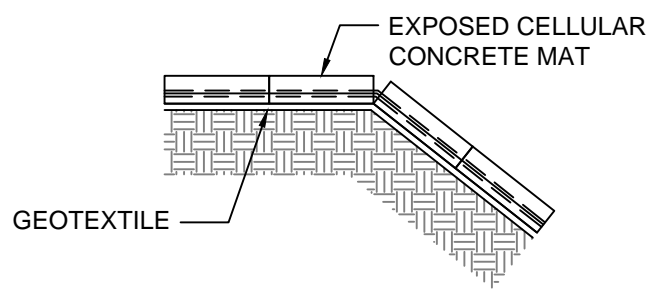
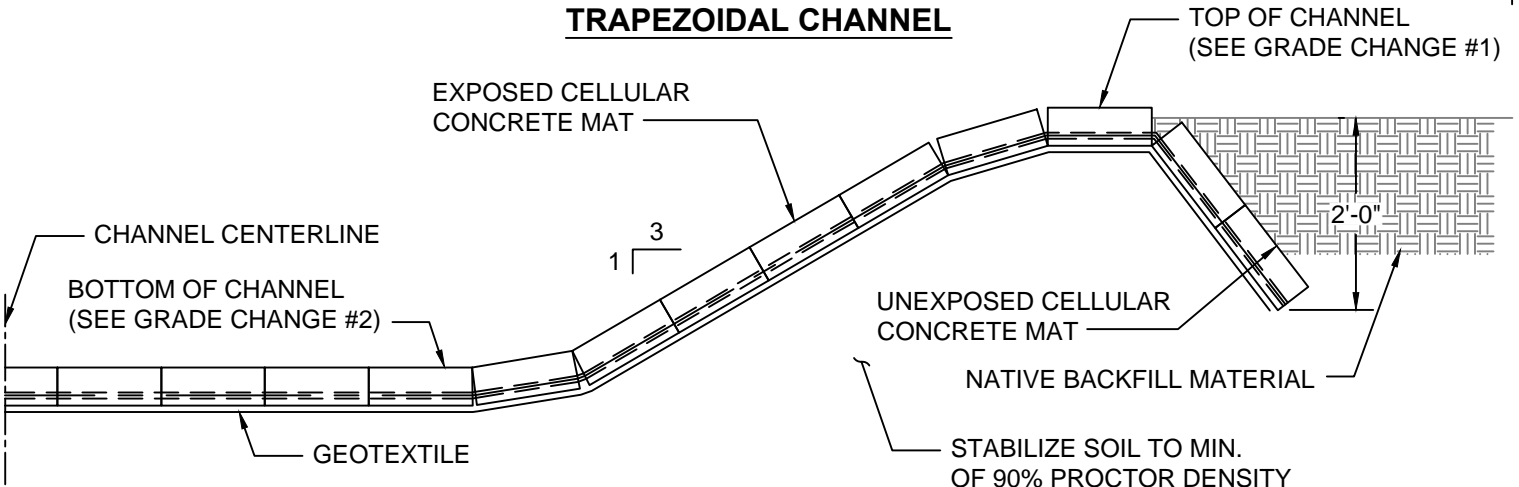

GRADE CHANGE #1

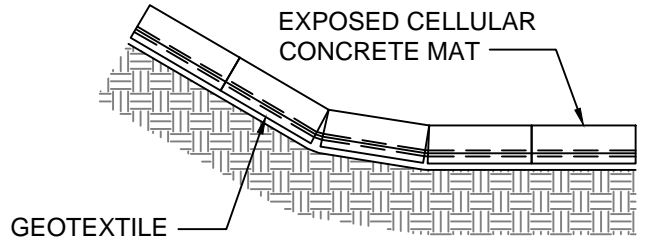

GRADE CHANGE #2

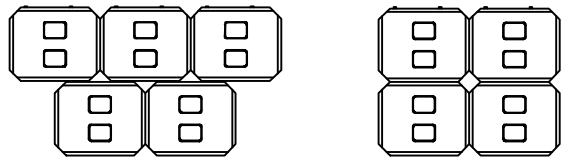

Channel Flex
Flexible Revetment System

EROSION PREVENTION PRODUCTS
P.O. Box 891586
Houston, TX 77289-1586
(713)947-6889

**TRAPEZOIDAL CHANNEL
DETAIL**

CAD File Name:	TRAP-CHA
SCALE: N/A	SHEET 4 OF 8

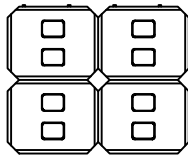
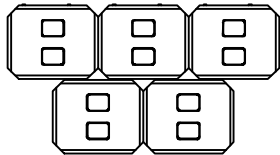
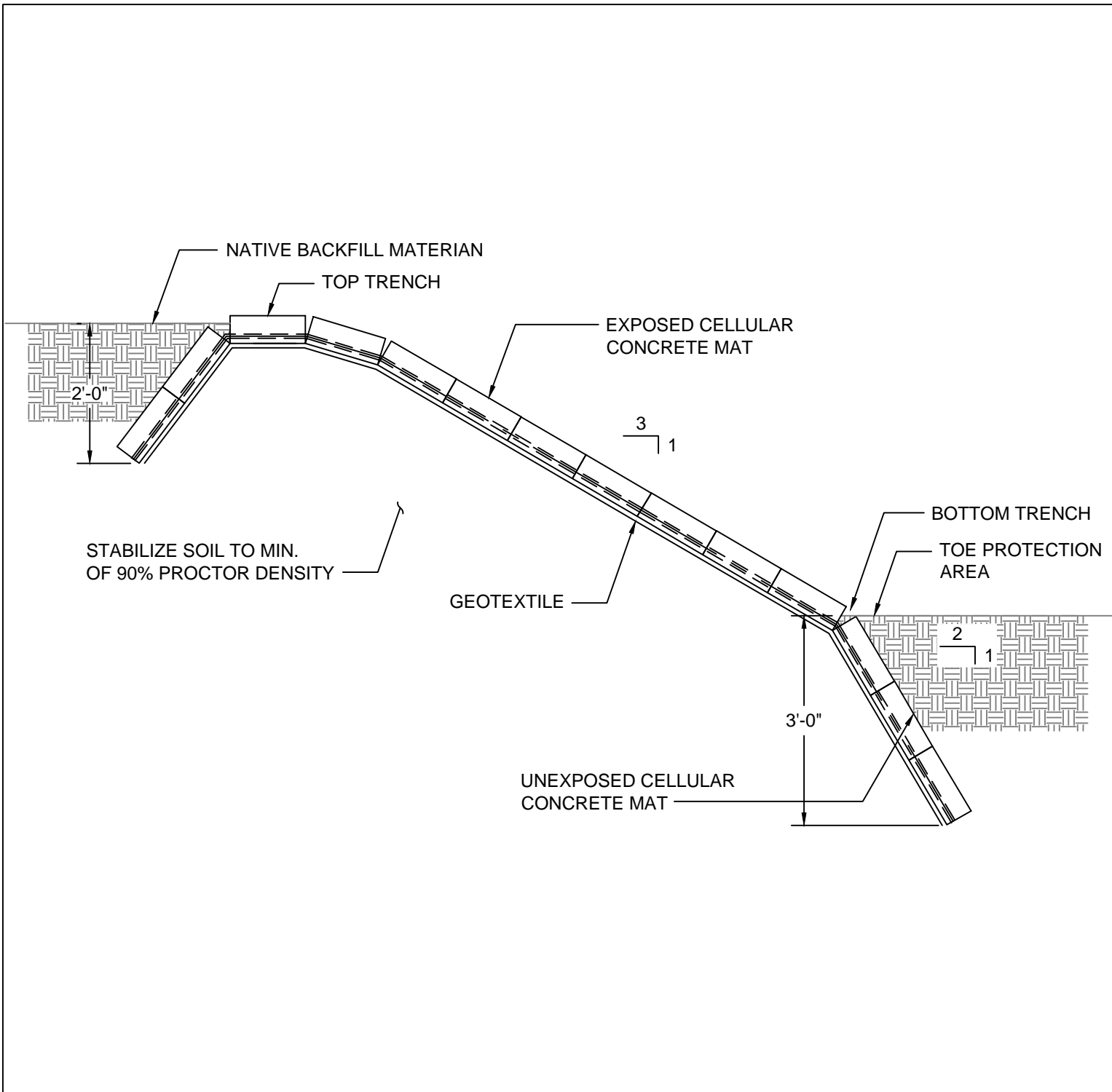

Channel Flex

Flexible Revetment System

EROSION PREVENTION PRODUCTS

P.O. Box 891586
Houston, TX 77289-1586
(713)947-6889

STANDARD SLOPE DETAIL

CAD File Name:

SLOPE 3 1

SCALE: N/A

SHEET 5 OF 8

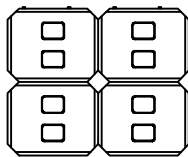
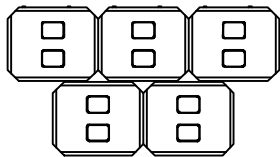
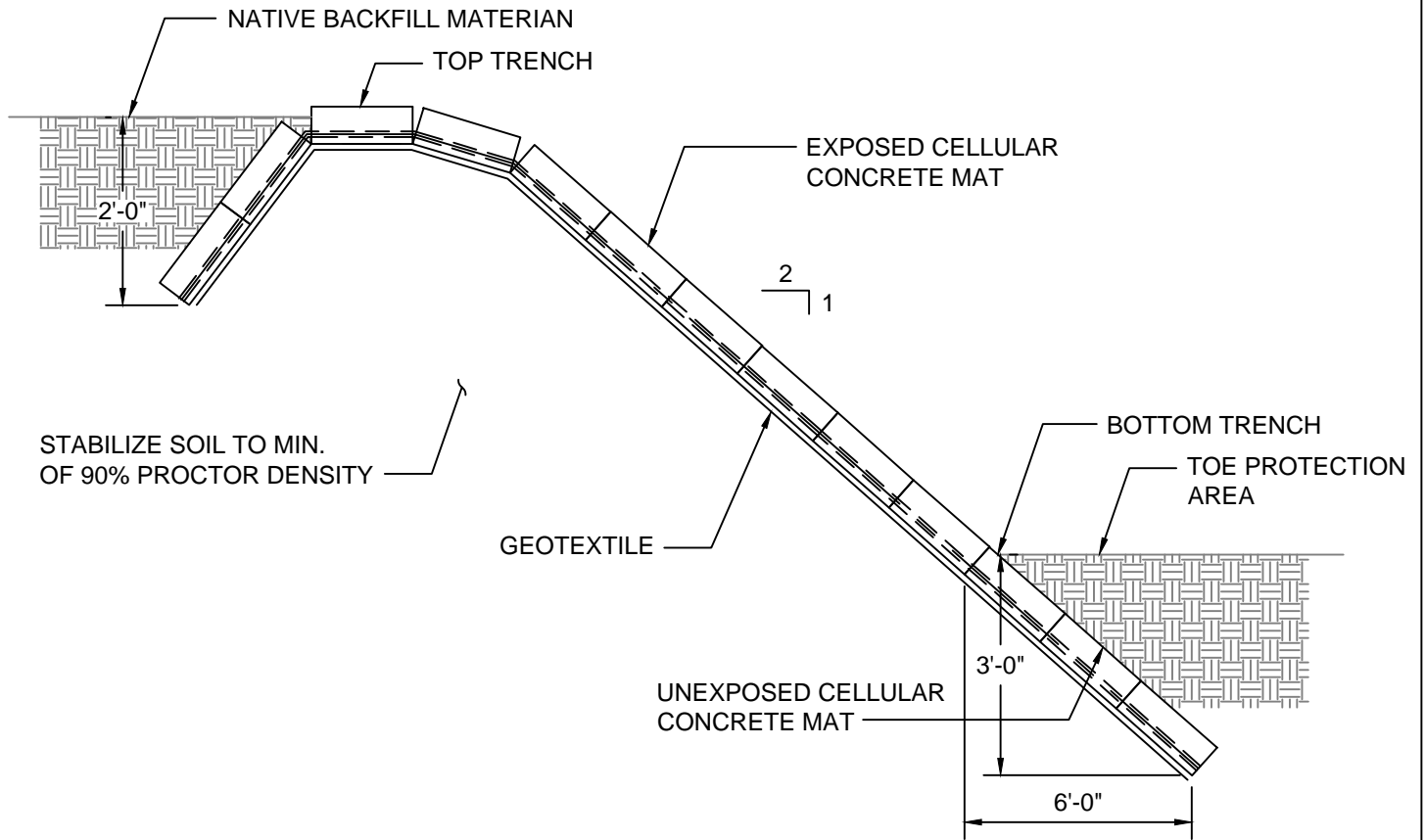

Channel Flex

Flexible Revetment System

EROSION PREVENTION PRODUCTS

P.O. Box 891586
Houston, TX 77289-1586
(713)947-6889

2:1 SLOPE DETAIL

CAD File Name:

SLOPE 2 1

SCALE: N/A

SHEET 6 OF 8

NATIVE BACKFILL MATERIAL

EXPOSED CELLULAR CONCRETE MAT

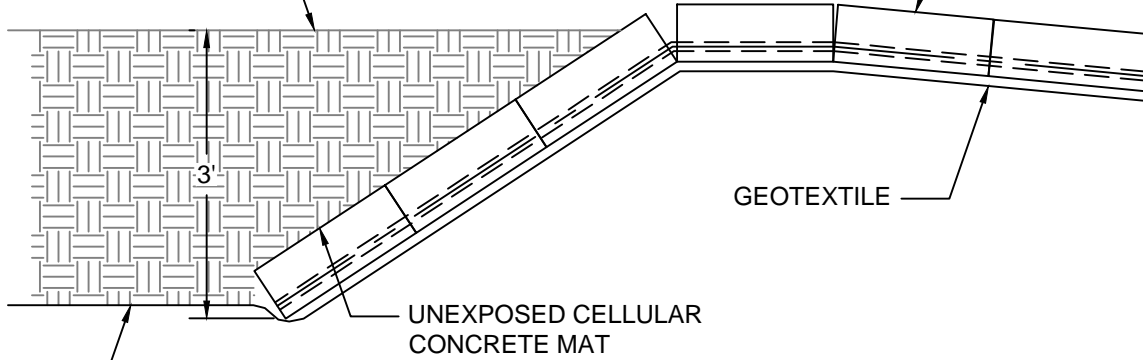

GEOTEXTILE

UNEXPOSED CELLULAR CONCRETE MAT

GEOTEXTILE

UPSTREAM FLANK

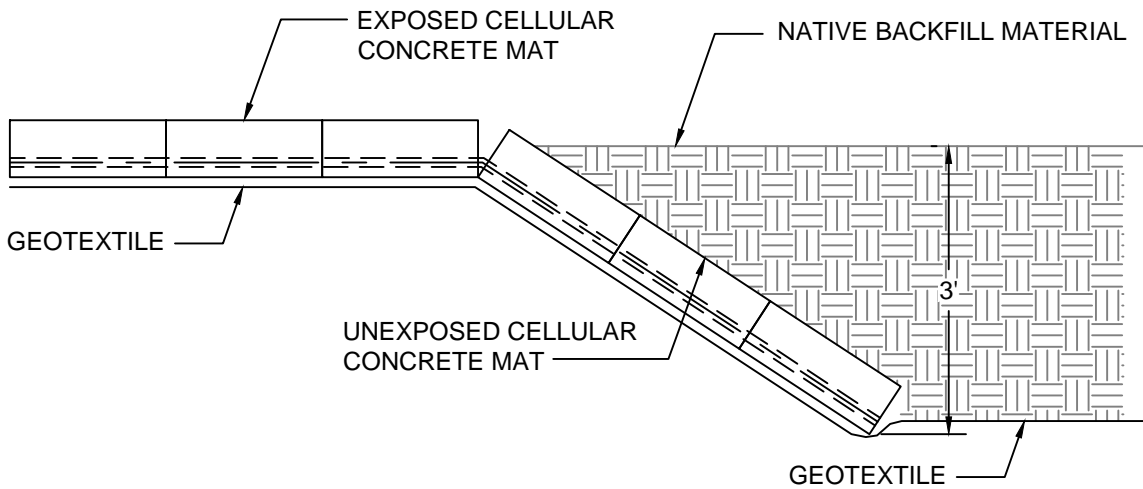

GEOTEXTILE

UNEXPOSED CELLULAR CONCRETE MAT

GEOTEXTILE

DOWNSTREAM FLANK

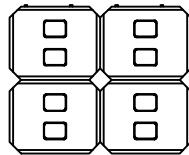
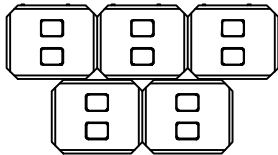

Channel Flex
Flexible Revetment System

EROSION PREVENTION PRODUCTS

P.O. Box 891586
Houston, TX 77289-1586
(713)947-6889

**UPSTREAM
AND DOWNSTREAM
FLANK DETAILS**

CAD File Name:

FLANKS

SCALE: N/A

SHEET 7 OF 8

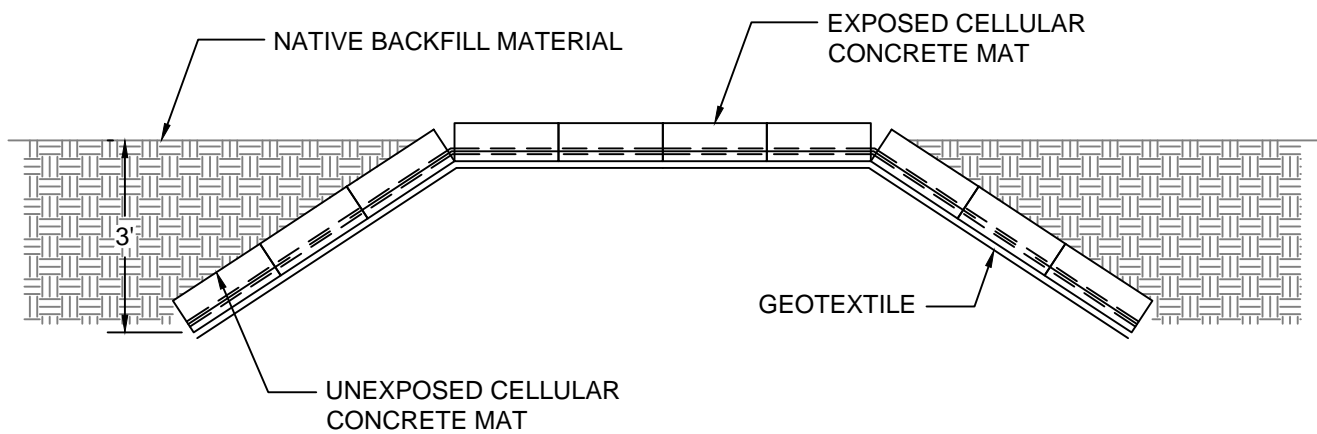

SIDE FLANKS

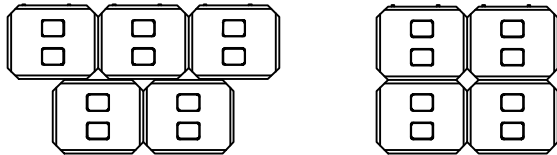

Channel Flex
Flexible Revetment System

EROSION PREVENTION PRODUCTS

P.O. Box 891586
Houston, TX 77289-1586
(713)947-6889

**CHANNEL FLEX
SIDE FLANK DETAIL**

CAD File Name:

SIDEFLANK

SCALE: N/A

SHEET 8 OF 8