

**NOTES:**

1. 6" AND 8" THICK BLOCKS ALSO AVAILABLE
2. EACH BLOCK COVERS 1.44 SQ. FT.

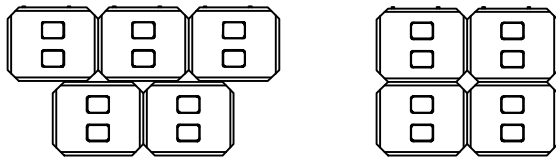

**Channel Flex**  
Flexible Revetment System

**EROSION PREVENTION PRODUCTS**

P.O. Box 891586  
Houston, TX 77289-1586  
(713)947-6889

**CHANNEL FLEX  
BLOCK DETAILS**

CAD File Name:

FLEX BLOCK

SCALE: N/A

SHEET 1 OF 8

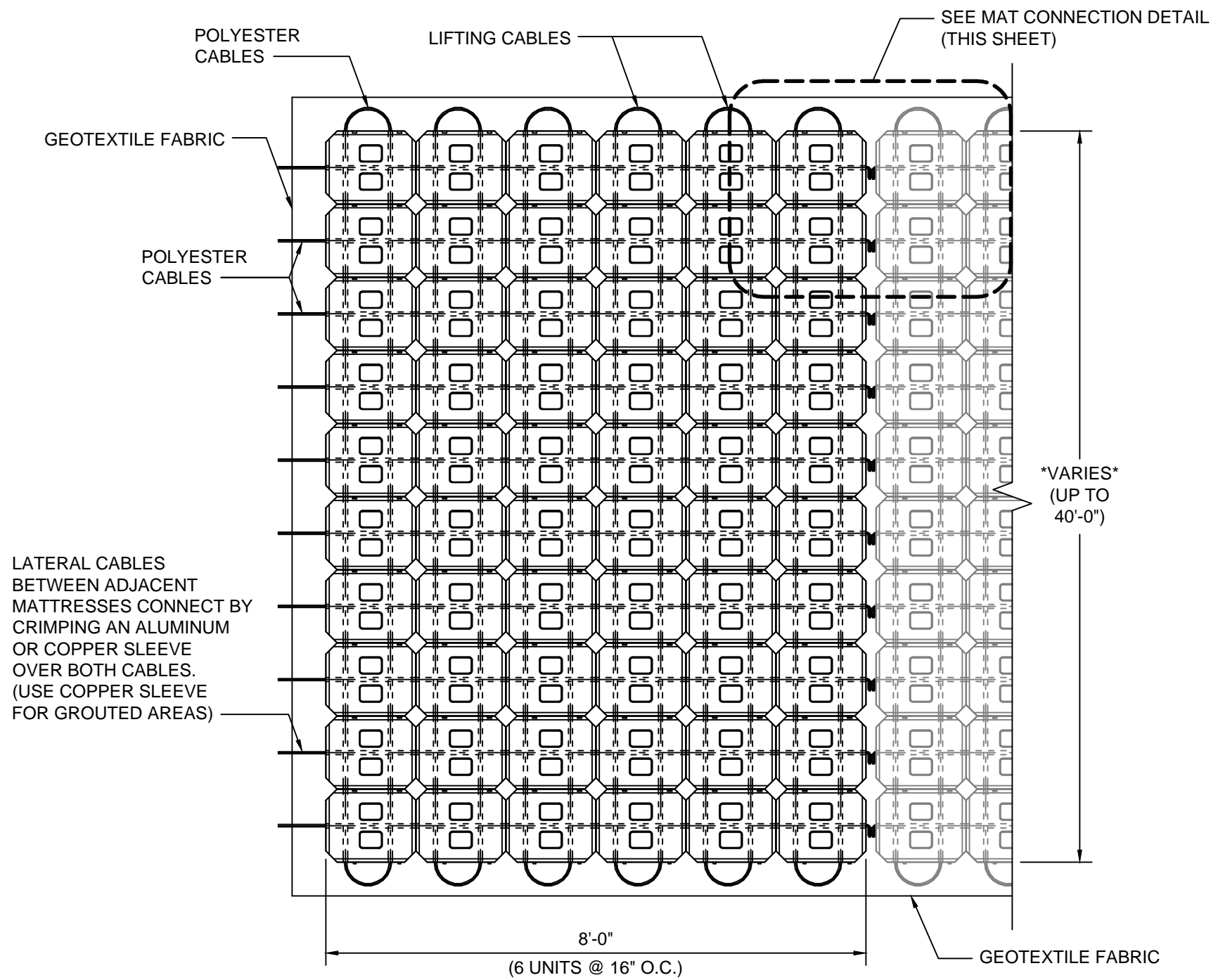

**PARALLEL ACBM  
PLAN VIEW**

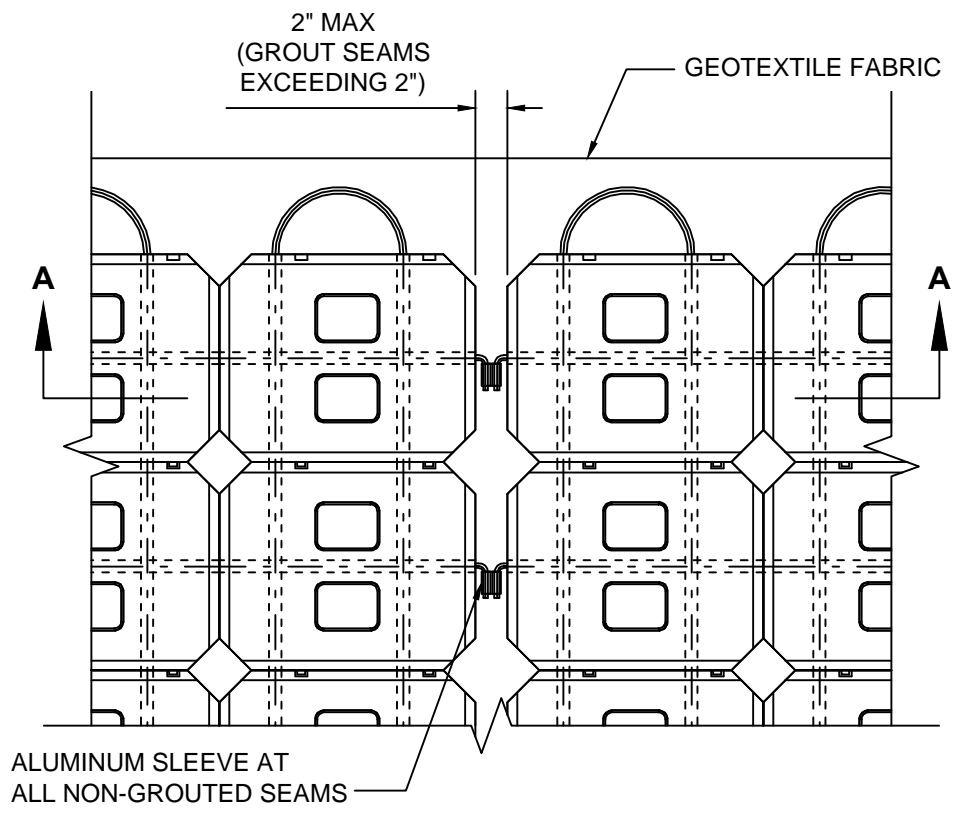

**TYPICAL CONNECTION  
OF TWO MATS**

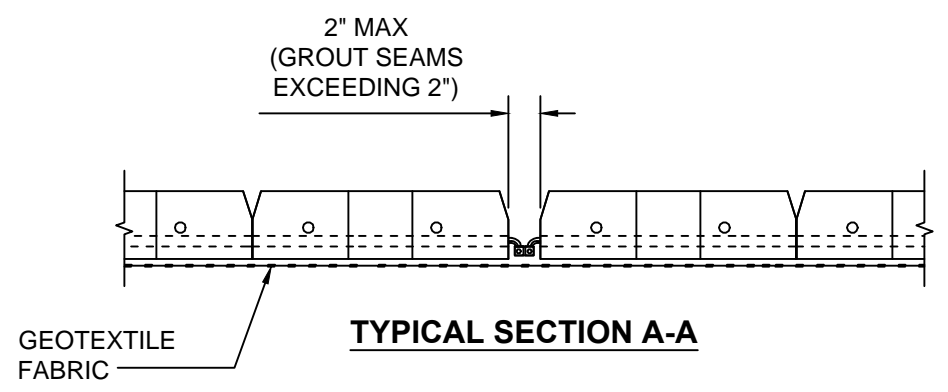

**TYPICAL SECTION A-A**

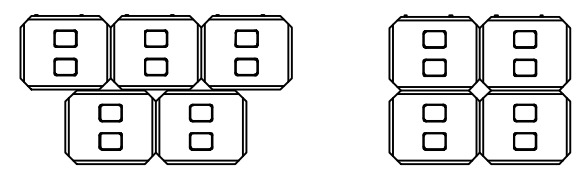

**Channel Flex**  
Flexible Revetment System

**EROSION PREVENTION PRODUCTS**  
P.O. Box 891586  
Houston, TX 77289-1586  
(713)947-6889

**PARALLEL ARTICULATED  
CONCRETE BLOCK  
MATTRESSES (ACBM)  
ASSEMBLY DETAIL**

CAD File Name: PARALLELMAT

SCALE: N/A SHEET 2 OF 8

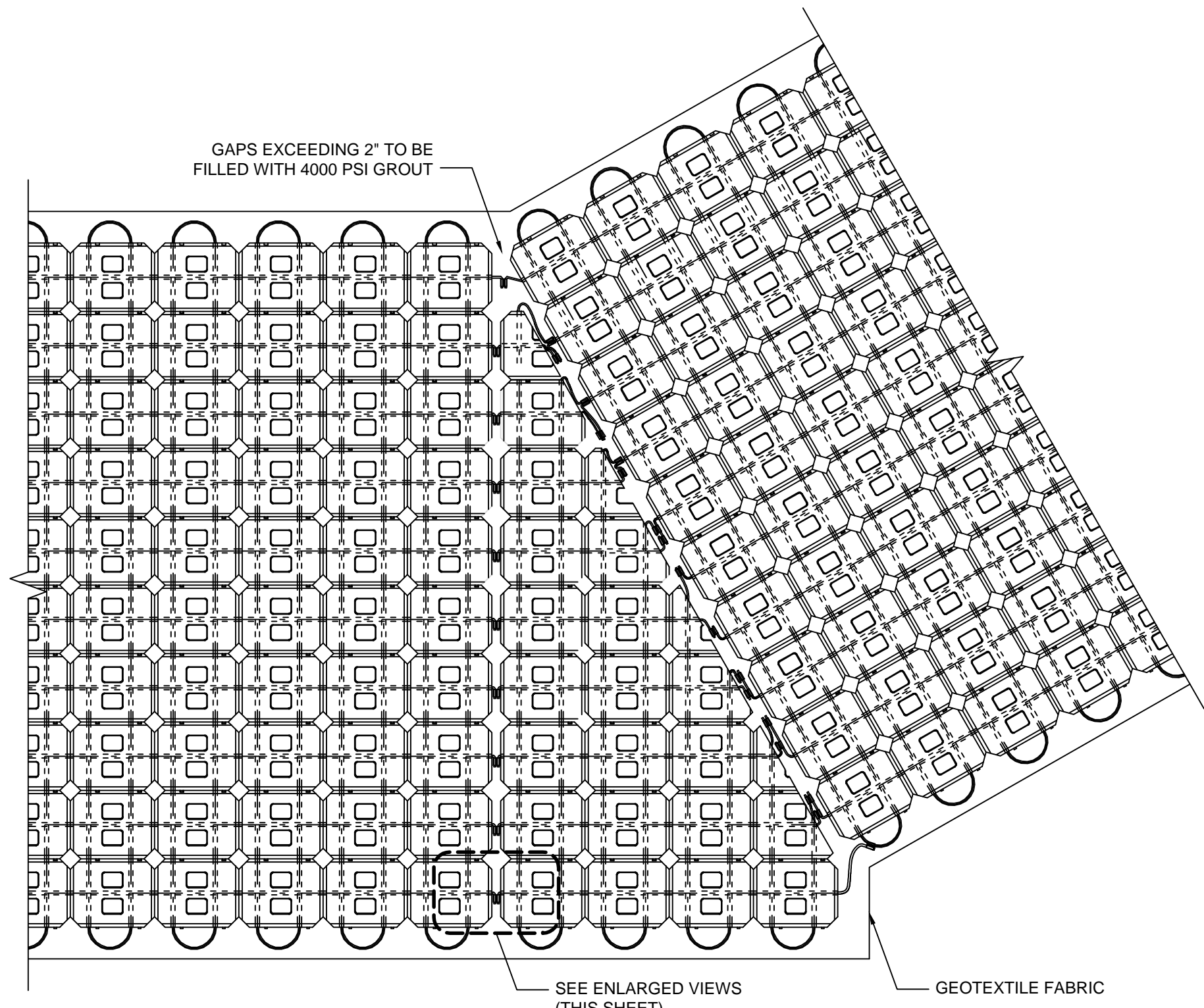

GAPS EXCEEDING 2" TO BE FILLED WITH 4000 PSI GROUT

SEE ENLARGED VIEWS (THIS SHEET)

GEOTEXTILE FABRIC

CAP JOINT NOT TO EXCEED 2"

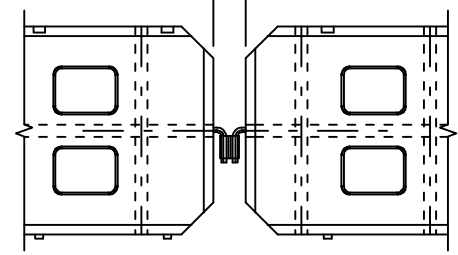

**TYPICAL MAT CONNECTION ENLARGED PLAN VIEW**

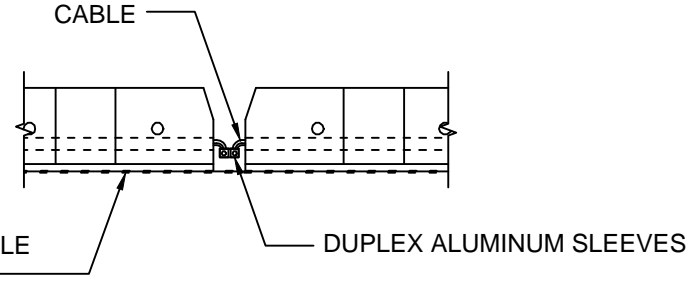

**TYPICAL MAT CONNECTION ENLARGED SECTION VIEW**

**ANGLED ACBM CONNECTION PLAN VIEW**

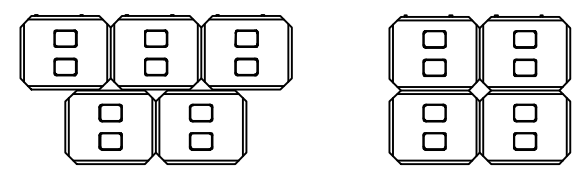

**Channel Flex**  
Flexible Revetment System

**EROSION PREVENTION PRODUCTS**  
P.O. Box 891586  
Houston, TX 77289-1586  
(713)947-6889

**ANGLED ARTICULATED CONCRETE BLOCK MATTRESSES (ACBM) CONNECTION DETAILS**

CAD File Name: ANGLEDMAT

SCALE: N/A SHEET 1 OF 8

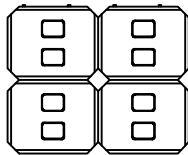
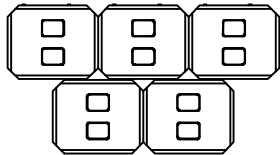
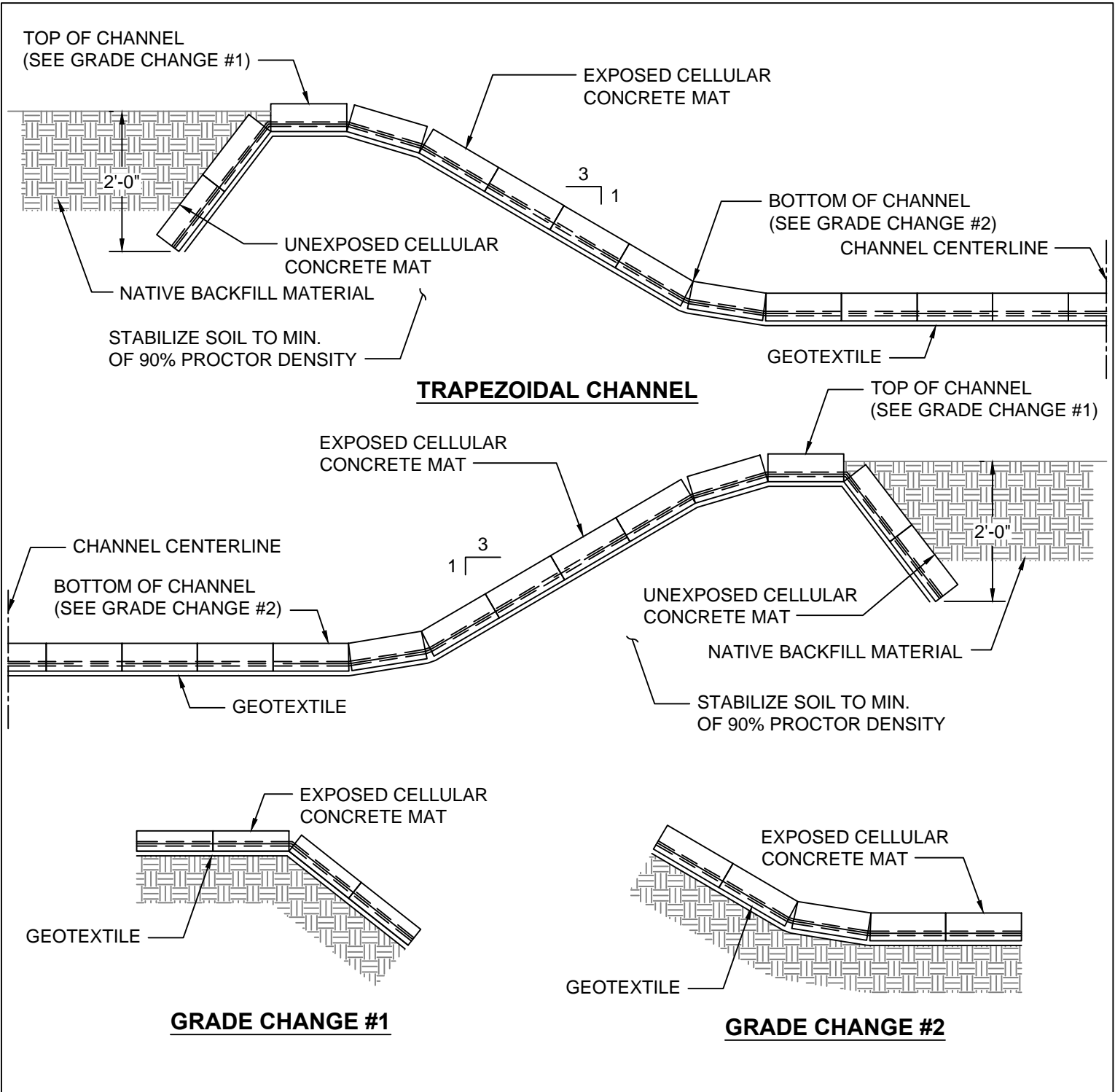

**Channel Flex**

Flexible Revetment System

**EROSION PREVENTION PRODUCTS**

P.O. Box 891586  
Houston, TX 77289-1586  
(713)947-6889

**TRAPEZOIDAL CHANNEL  
DETAIL**

CAD File Name:

TRAP-CHA

SCALE: N/A

SHEET 4 OF 8

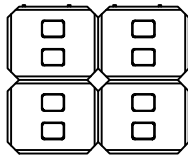
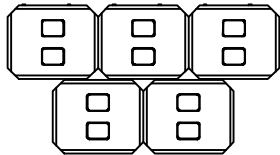
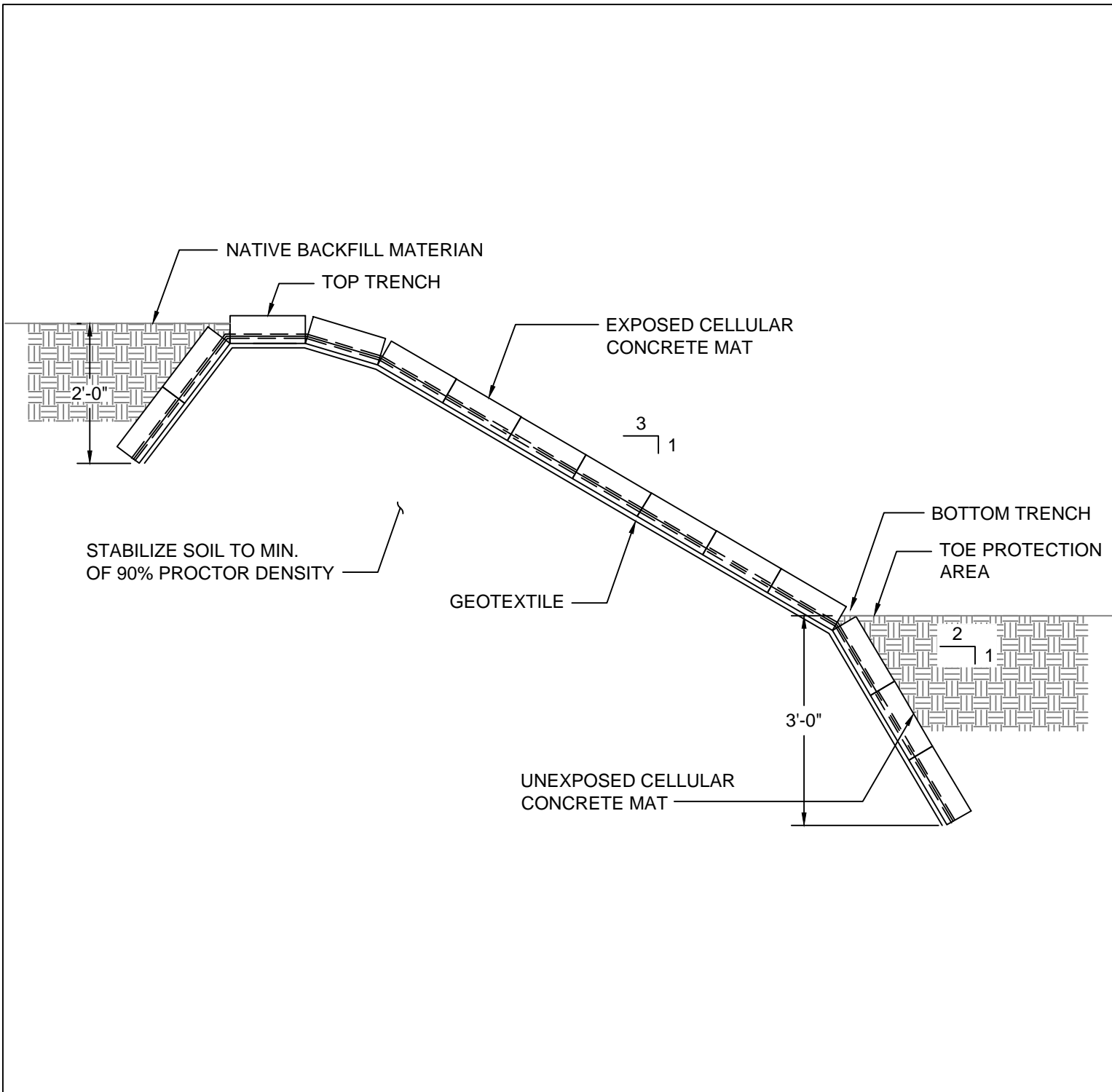

**Channel Flex**

Flexible Revetment System

**EROSION PREVENTION PRODUCTS**

P.O. Box 891586  
Houston, TX 77289-1586  
(713)947-6889

**STANDARD SLOPE DETAIL**

CAD File Name:

SLOPE 3 1

SCALE: N/A

SHEET 5 OF 8

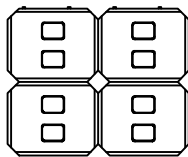
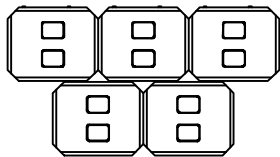
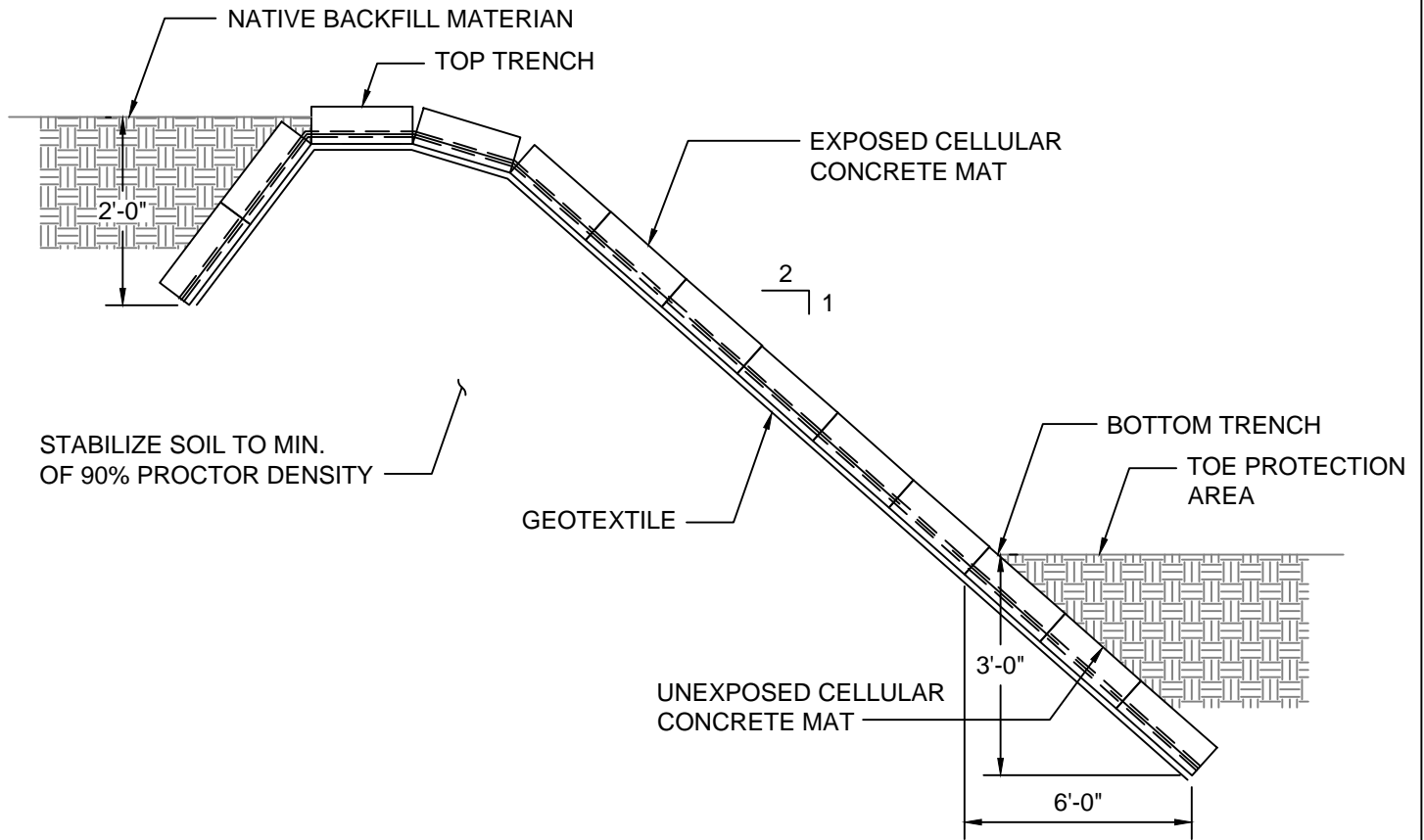

**Channel Flex**

Flexible Revetment System

**EROSION PREVENTION PRODUCTS**

P.O. Box 891586  
 Houston, TX 77289-1586  
 (713)947-6889

**2:1 SLOPE DETAIL**

CAD File Name:

SLOPE 2 1

SCALE: N/A

SHEET 6 OF 8

NATIVE BACKFILL MATERIAL

EXPOSED CELLULAR CONCRETE MAT

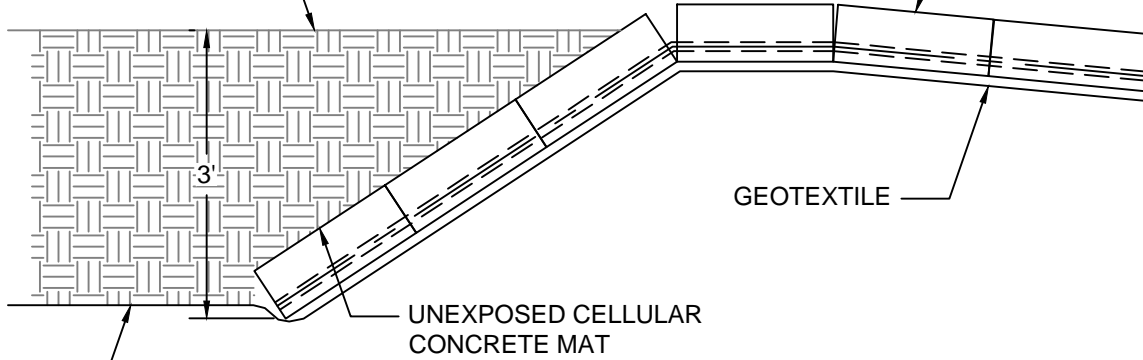

GEOTEXTILE

UNEXPOSED CELLULAR CONCRETE MAT

GEOTEXTILE

**UPSTREAM FLANK**

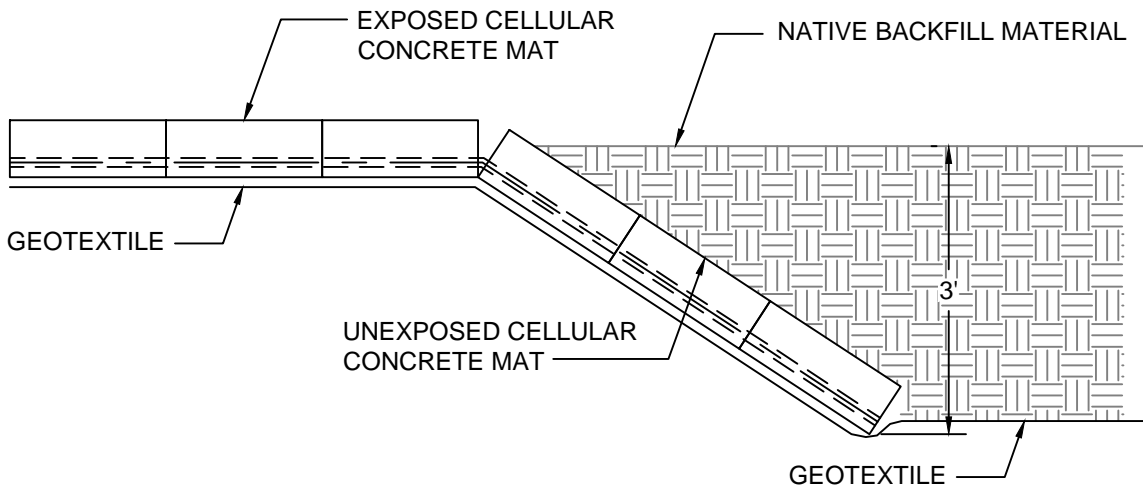

GEOTEXTILE

EXPOSED CELLULAR CONCRETE MAT

NATIVE BACKFILL MATERIAL

UNEXPOSED CELLULAR CONCRETE MAT

GEOTEXTILE

**DOWNSTREAM FLANK**

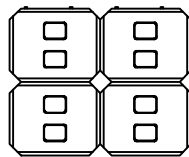
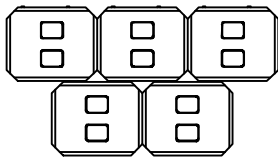

**Channel Flex**  
Flexible Revetment System

**EROSION PREVENTION PRODUCTS**

P.O. Box 891586  
Houston, TX 77289-1586  
(713)947-6889

**UPSTREAM  
AND DOWNSTREAM  
FLANK DETAILS**

CAD File Name:

FLANKS

SCALE: N/A

SHEET 7 OF 8

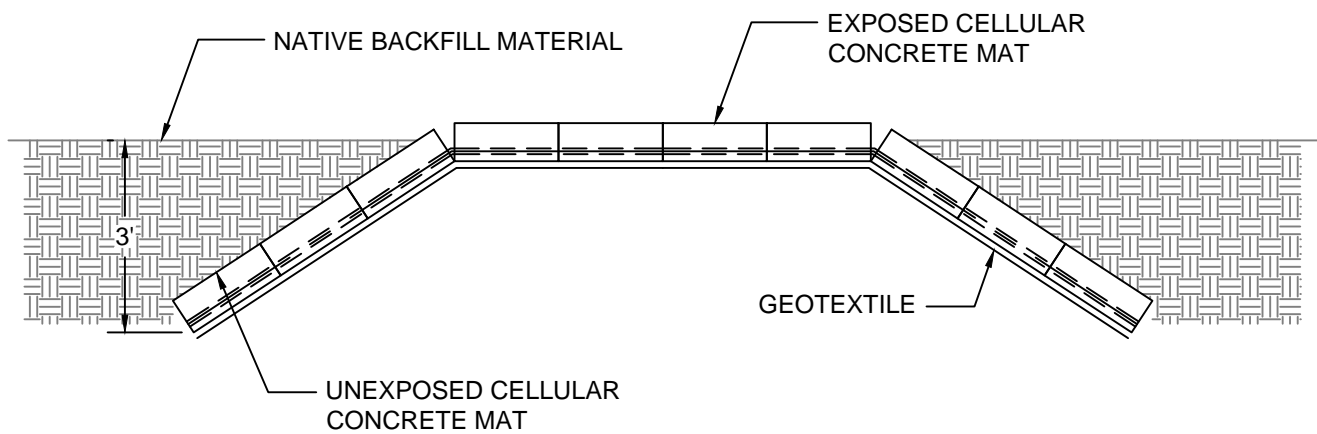

**SIDE FLANKS**

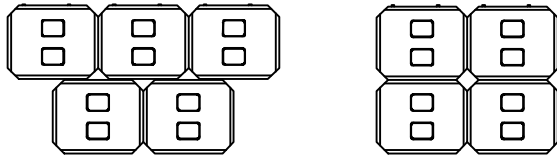

**Channel Flex**  
Flexible Revetment System

**EROSION PREVENTION PRODUCTS**

P.O. Box 891586  
Houston, TX 77289-1586  
(713)947-6889

**CHANNEL FLEX  
SIDE FLANK DETAIL**

CAD File Name:

SIDEFLANK

SCALE: N/A

SHEET 8 OF 8